



woods furniture

Storage



Personal Lockable Storage

Woods' PLS series is specifically designed and manufactured to the highest standards to ensure the safeguarding of personal belongings. These high quality Australian made lockers will ensure peace of mind that valuable items are safe and secure.



Woods Furniture created and designed the innovative Woods Security Locker in the late 1980's. Today, Woods continues to lead the way with the evolution of personal lockable storage with the PLS Series.

The strength and durability of the locker design, has seen this product in continuous use for over 25 years in the most testing of environments. The introduction of EO Decorwood has added further to the practicality and aesthetics of the product.

Frames

The locker frames are manufactured from heavy duty steel. These frames give the unit their amazing rigidity.

Carcass

The locker carcass is manufactured from 16mm EO laminated MDF and is available in 4 practical colours. The laminated carcass and doors with sealed edges are moisture resistant and easy to clean. Lockers sit on a 98% wood/plastic recycled composite base.

Doors and Hinges

The ultra tough doors and unique Woods hinge system give these lockers their superior security and longevity of use. 18mm EO doors are so much tougher than metal and plastic doors. The doors are available in a range of vibrant and practical colours.

Optional Features:

Sloping Hood Option

To prevent unwanted items being placed on top of the units, we provide the option of fitted sloping hoods. The finish of the hoods will match the carcass.

Identification Plaques

Our numbering system offers a wide variety of colour coded plaques to complement the door and frame colours. Our system assists with clear identification with numbers engraved into plaques that will stand the test of time. Plaque numbering can be customised to fit a school's requirements.

Configurations

With 3 door sizes and a number of locker bank configurations, you are able to maximise space while meeting your students' storage needs.

Door Layout

While the most common locker bank consists of 1 door finish, Woods offers the option of multiple door colours to create a visually impressive display.

Ultimate Security

Our locally designed and manufactured heavy duty cam lock has been specifically created for use in the education market to give you peace of mind that valuable items can be stored safely and securely. The design also allows for schools to supply their own padlocks or combination locks as required.



The Woods brand is synonymous with strength and longevity. The units are Australian made and with their durable design, will provide many years of trouble free use. We stand by every product that carries the Woods name.

PLS A Series

Full height lockers, available in 4 door or 6 door configuration.

Features
Optional Hood

Dimensions
Door size: 870mm (h) x 327mm (w)



PLS C Series

Full height lockers, available in 6 door or 9 door configuration.

Features
Optional Hood

Dimensions
Door size: 570mm (h) x 327mm (w)



PLS B Series

Half height lockers, available in 2 door or 3 door configuration.
For added flexibility try the MB Series, featuring 75mm heavy duty lockable castors.

Features
Available in static or mobile
Optional Hood

Dimensions
Door size: 870mm (h) x 327mm (w)

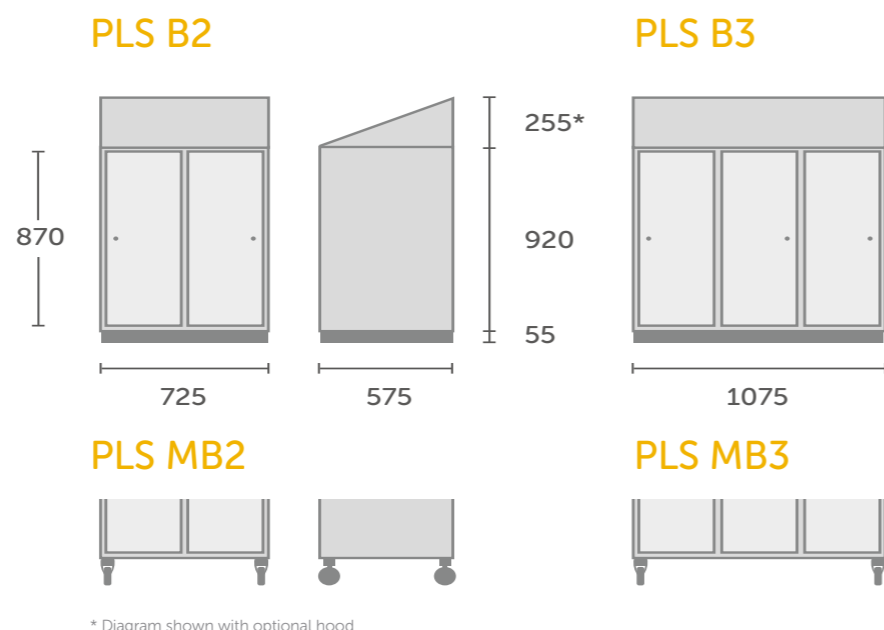

PLS D Series

Mid-height lockers, available in 4 door or 6 door configuration.
For added flexibility try the MD Series, featuring 75mm heavy duty lockable castors.

Features
Available in static or mobile
Optional Hood

Dimensions
Door size: 570mm (h) x 327mm (w)

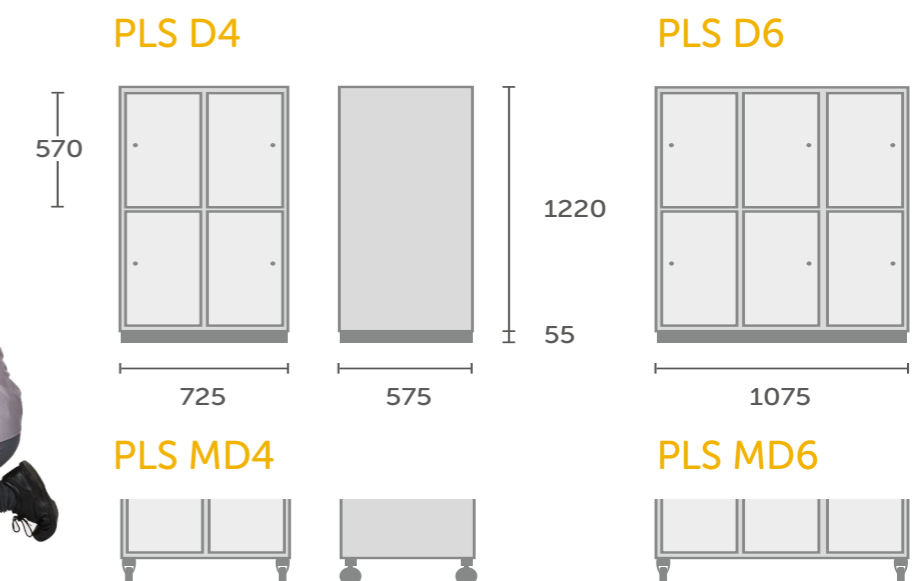

PLS G Series

Full height lockers, available in 8 door or 12 door configuration.

Features
Optional Hood

Dimensions
Door size: 423mm (h) x 327mm (w)

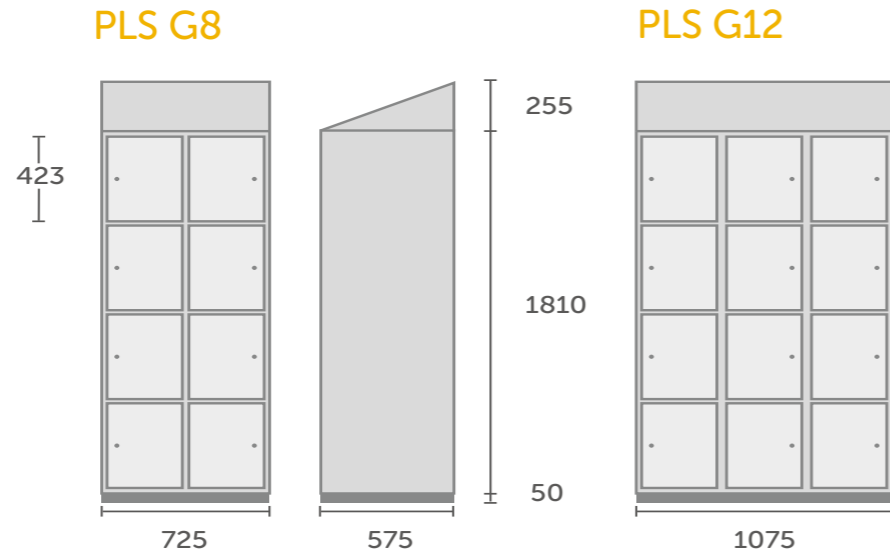

* Diagram shown with optional hood

PLS H Series

Half height lockers, available in 4 door or 6 door configuration. For added flexibility try the MB Series, featuring 75mm heavy duty lockable castors.

Features
Available in static or mobile
Optional Hood

Dimensions
Door size 423mm (h) x 327mm (w)

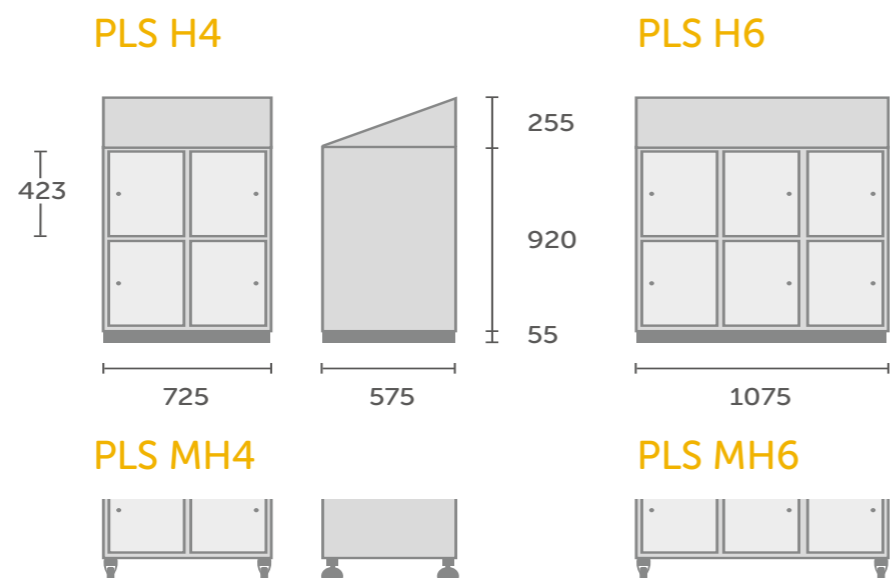

* Diagram shown with optional hood

JS Storage Trolleys™

The perfect storage solutions for all classrooms. Flexible and adaptable, Woods' JS Storage Trolleys™ come in 3 sizes and cater for various storage applications. Perfect for art rooms, workshops, science labs and activity centres.

Configuration

Each section of the JS Storage Trolley™ holds either 8 x red tubs, 4 x black tubs, 2 x blue tubs or a combination of tubs. Adjustable brackets clip on to suit the tub configuration of your choice.

Tub Options

- Red Tub**
75mm (h) x 312mm (w) x 427mm (d)
- Black Tub**
150mm (h) x 312mm (w) x 427mm (d)
- Blue Tub**
300mm (h) x 312mm (w) x 427mm (d)

Considerations

Tubs are optional and need to be ordered separately.

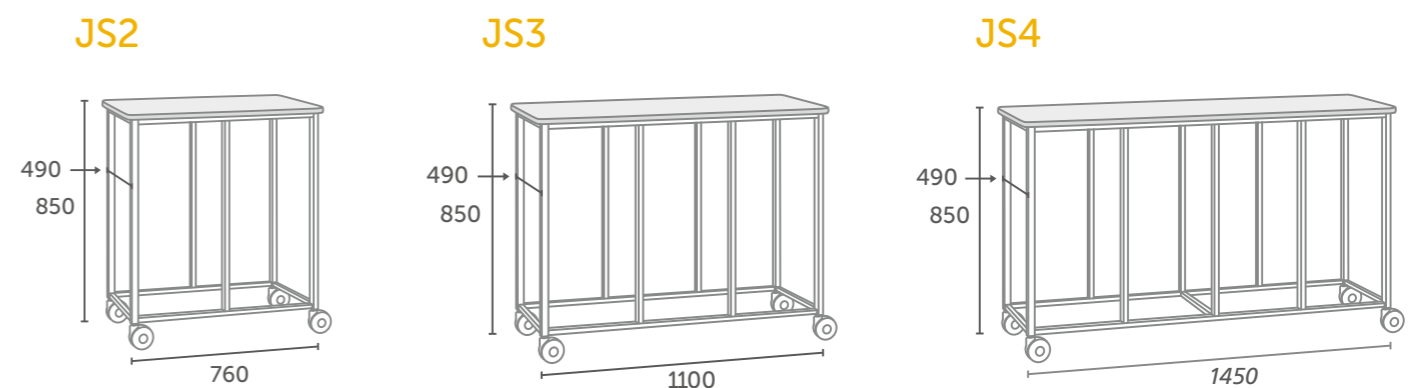

Australian design registration 343383

Mobile Storage Porter Type A

Designed with a uniform recess to hold our black tubs, text books, craft materials or whatever your daily classroom needs require.

Configuration

Each recess holds one Woods black tub.
Recess Dimensions:
 240mm (h) x 377mm (w) x 460mm (d)

Tub Options

Black Tub
 150mm (h) x 312mm (w) x 427mm (d)

Considerations

Tubs are optional and need to be ordered separately.



MSP A8

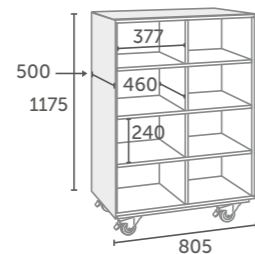

MSP A12

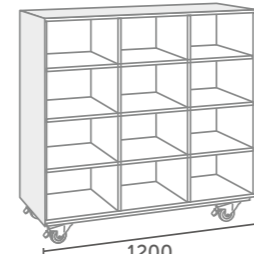

MSP A16

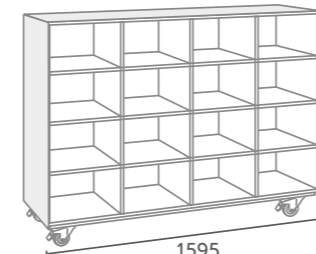

MSP Type C

Dual sized recesses give you optimum storage flexibility. Holding our black and blue tubs, you'll be ready whatever your classroom storage needs.

Configuration

Each recess holds one Woods black/blue tub.
Recess Dimensions:
 175mm (h) x 377mm (w) x 460mm (d)
 305mm (h) x 377mm (w) x 460mm (d)

Tub Options

Black Tub
 150mm (h) x 312mm (w) x 427mm (d)
Blue Tub
 300mm (h) x 312mm (w) x 427mm (d)

Considerations

Tubs are optional and need to be ordered separately.



MSP C8

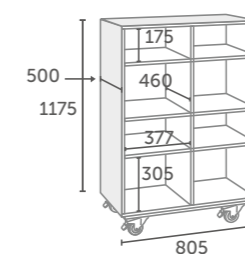

MSP C12

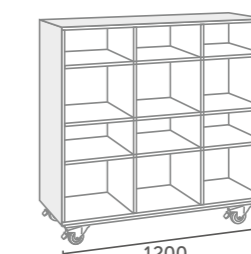

MSP C16

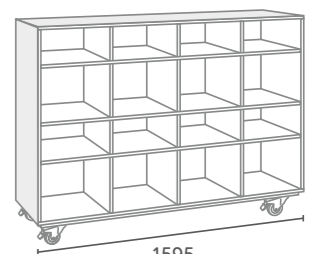

MSP Type B

Designed with a uniform recess to hold our blue tubs, school bags, science materials or whatever your daily classroom needs require.

Configuration

Each recess holds one Woods blue tub.
Recess Dimensions:
 325mm (h) x 377mm (w) x 460mm (d)

Tub Options

Blue Tub
 300mm (h) x 312mm (w) x 427mm (d)

Considerations

Tubs are optional and need to be ordered separately.



MSP B6

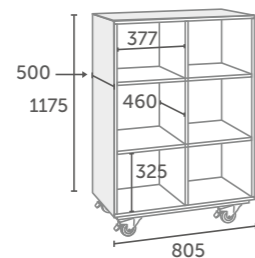

MSP B9

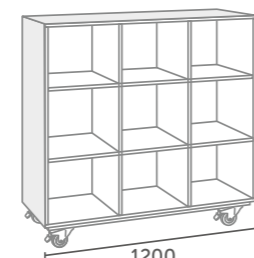

MSP B12

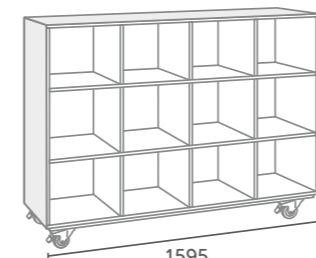

MSP Extras

Great options can be added to the back panel of the Mobile Storage Porters.

White Board on Back Panel

Available with MSP A16, MSP B12 and MSP C16.

Pin Board on Back Panel

Available with all Mobile Storage Porter configurations and sizes.

Numbered Compartments

Available with all Mobile Storage Porter configurations and sizes.



Woods' Mobile Storage Trolley

The perfect storage solution for all classrooms. Flexible and adaptable, Woods' Mobile Storage Trolleys come in 3 sizes and cater for various storage applications. Perfect for art rooms, workshops, science labs and activity centres.

Configuration

Each section includes five Woods white tubs.

Tub Size

White Only
128mm (h) x 320mm (w) x 430mm (d)

Dimensions

MST5: 900mm (h) x 420mm (w) x 485mm (d)
MST10: 900mm (h) x 755mm (w) x 1125mm (d)
MST15: 900mm (h) x 420mm (w) x 485mm (d)



MST 5

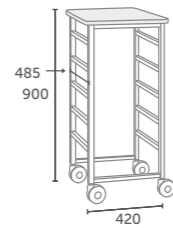

MST 10

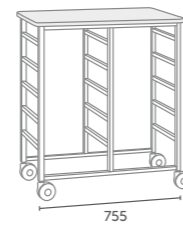

MST 15

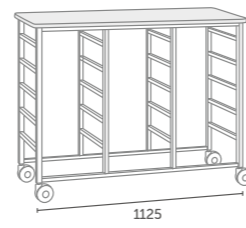

Multi Purpose Trolley

Versatile storage for the modern classroom. Use as a multimedia unit, display stand or storage trolley for larger sized items.

Features

3 large open shelves for optimum storage
75mm locking castors

Dimensions

1075mm (h) x 900mm (w) x 560mm (d)



Bookcases

Strong stable bookcases and shelves for a variety of uses.

Dimensions

BC1: 900mm (h) x 900mm (w) x 300mm (d)
BC2: 1200mm (h) x 900mm (w) x 300mm (d)
BC3: 1500mm (h) x 900mm (w) x 300mm (d)
BC4: 1800mm (h) x 900mm (w) x 300mm (d)

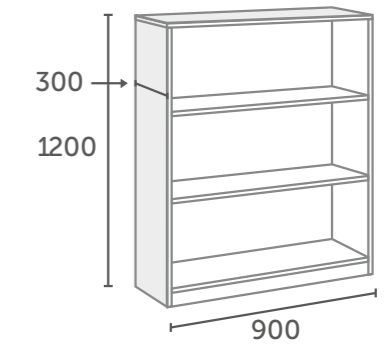

BC 2

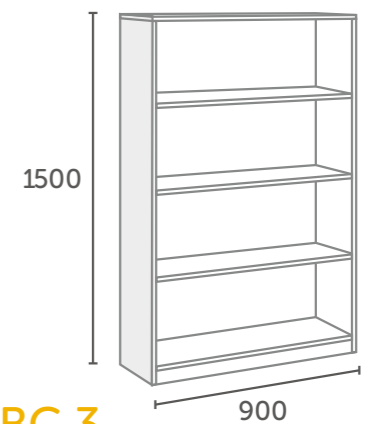

BC 3

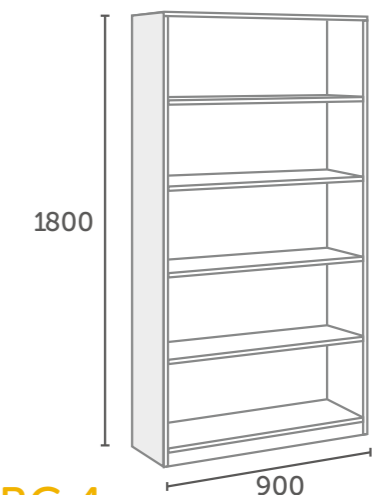

BC 4

Mobile Book Mate

The Mobile Book Mate is double-sided with adjustable shelves, making it ideal for storing books of all sizes. Fitted with heavy duty locking castors, this mobile unit is perfect for the modern classroom, library or collaborative learning area.

Dimensions
1325mm (h) x 1600mm (w) x 580mm (d)



Book Buddy

The Book Buddy is the perfect display unit for books of all sizes with fixed shelves on one side and adjustable shelves on the reverse. Heavy duty castors means the Book Buddy can be moved around anywhere.

Features
Available in 4 Laminate colours to coordinate with the Primary Teaching Unit™ and The Island, Woods Book Buddy will brighten up any reading area.

Dimensions
880mm (h) x 1000mm (w)
1180mm (h) x 1000mm (w)



Big Book Buddy

The Big Book Buddy is ideal for displaying and storing books of all sizes. Fitted with heavy duty castors, this mobile unit is perfect for the modern classroom, library or collaborative learning area.

Features
Available in a brilliant range of colour options.

Dimensions
1200mm (h) x 1000mm (w) x 500mm (d)

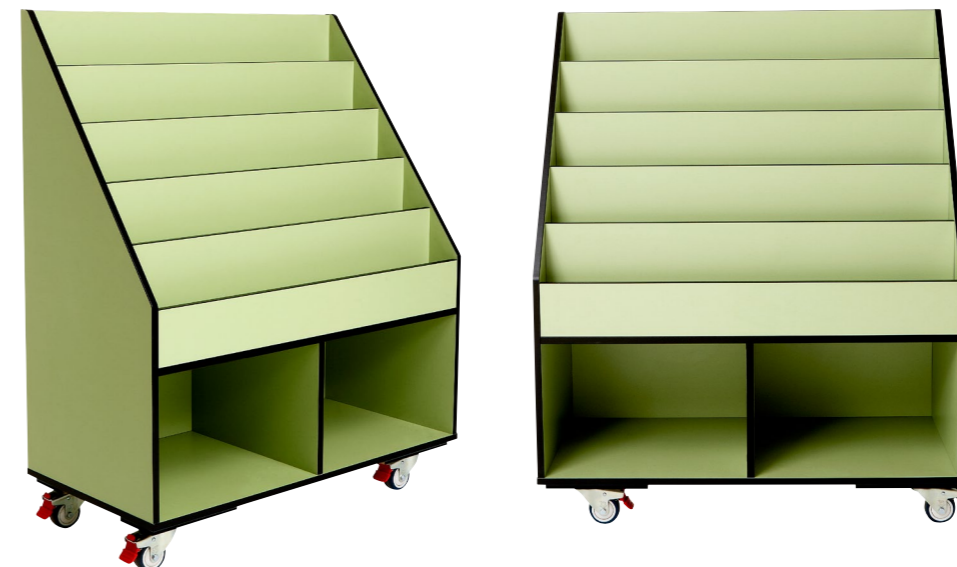

Finish Options

Locker Doors & Mobile Storage Panelling

18mm EO Decorwood

This is a medium density fibreboard bonded on both sides with hard wearing melamine decorative surface. The wood content used is 60% pre-consumer recycled and 40% reclaimed silviculture fibre. Edges are sealed and coated with a black polyurethane edge. These doors contain no PVC.



Locker Carcass

16mm EO Decorwood

This is a medium density fibreboard bonded on both sides with hard wearing melamine decorative surface. The wood content used is 60% pre-consumer recycled and 40% reclaimed silviculture fibre. Edges are sealed and coated with a black polyurethane edge. These carcasses contain no PVC.



Locker Hood System

To prevent unwanted items being placed on top of the units, we provide the option of fitted sloping hoods. The finish of the hoods will match the carcass.

Standard

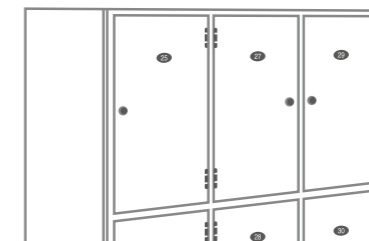

Fitted hood option

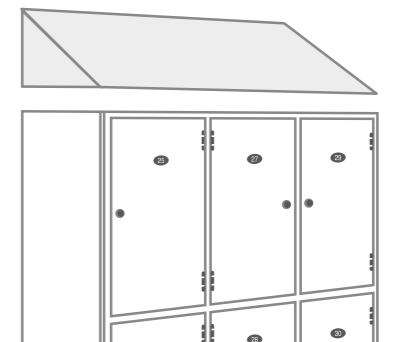

Locker Doors Only

13mm Compact Laminate Doors

This is a durable decorative panel made from thermosetting resins, homogeneously reinforced with cellulose fibres and manufactured under high pressure and temperature. The doors are extremely durable and moisture resistant. This is an E1 rated product.



Locker & Mobile Storage Steel Frame Colours

Durable powder-coated steel frame for strength and support.

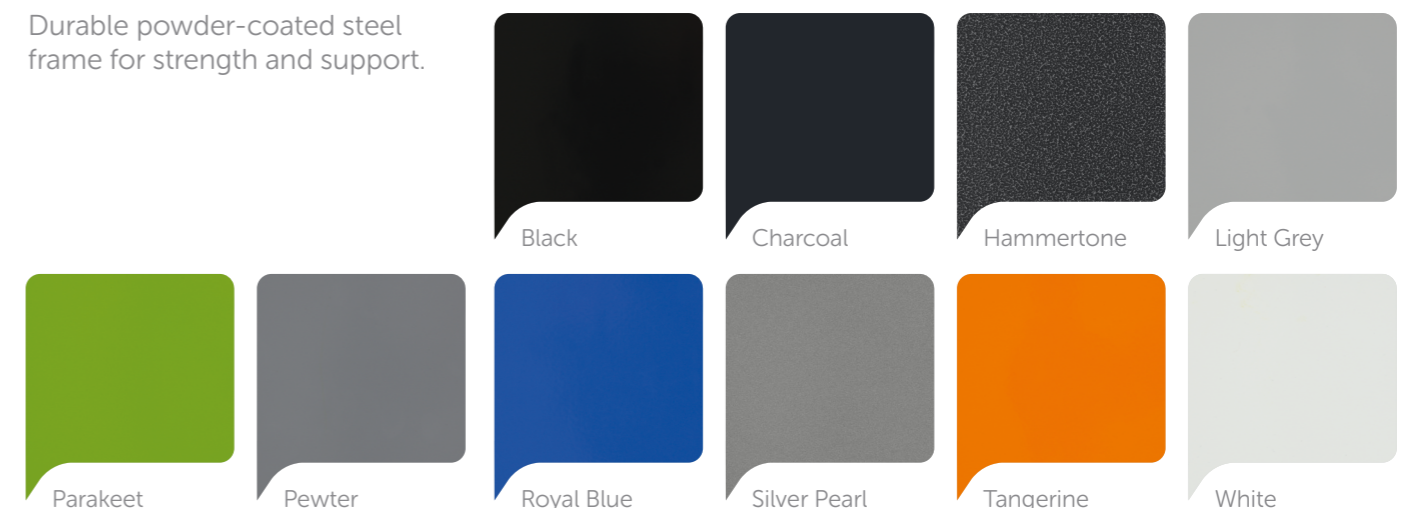

Locker & Mobile Storage Numbering

Our numbering system offers a wide variety of colour coded plaques to complement the door and frame colours. Our system assists with clear identification with numbers engraved into plaques that will stand the test of time. Plaque numbering can be customised to fit a school's requirements.

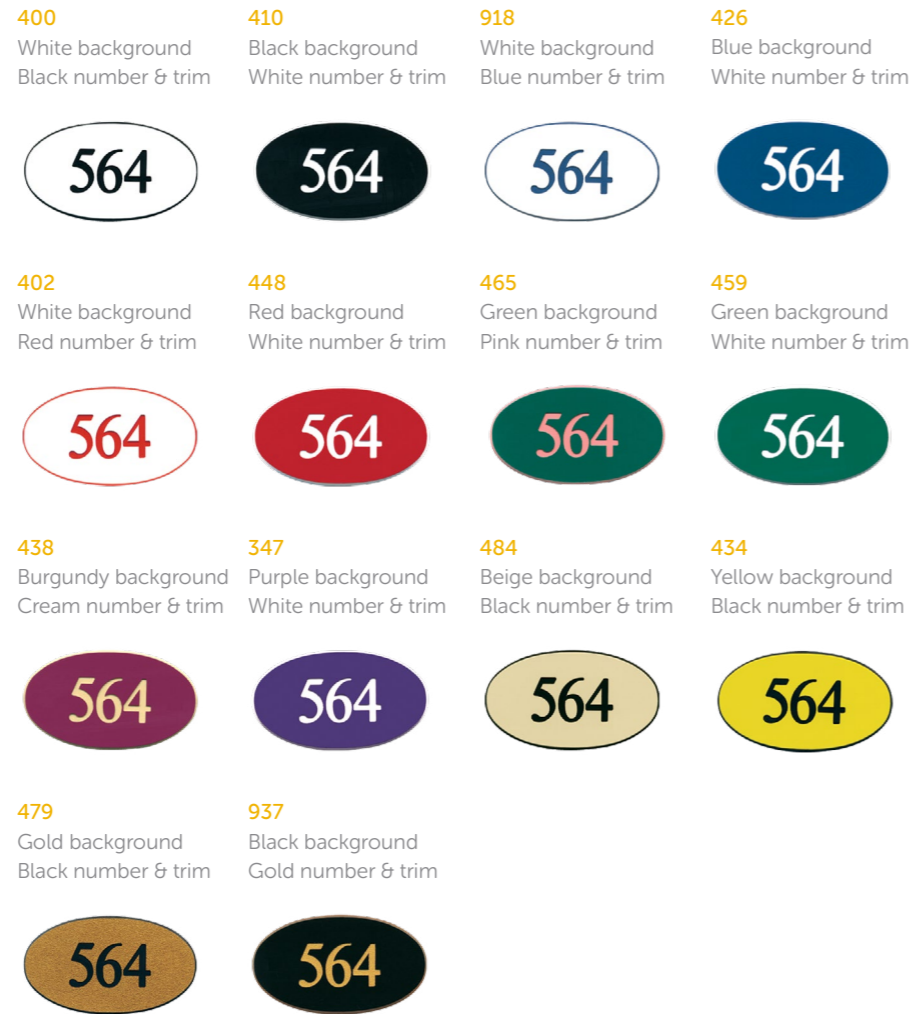

Mobile Storage Tubs

Our sturdy storage tubs are easy to clean and can withstand the most demanding classroom environment.





woods
furniture

Head Office
564 Geelong Road,
Brooklyn, Victoria,
3012 Australia

P: 1800 004 555
F: 1800 776 500
E: sales@woods furniture.com.au
©2015 Woods Furniture Pty Ltd